



DIGITAL PORTABLE RADIO

数字手持终端

OWNER'S MANUAL

使用说明书

Hytera 海能达



Preface

Thanks for your favor in our product. This manual is helpful for you to quickly know how to use the product. Please refer to the corresponding Feature Book for detailed features and operations.

This manual is applicable to the following product:
PD502i Digital Portable Radio

DIGITAL PORTABLE RADIO

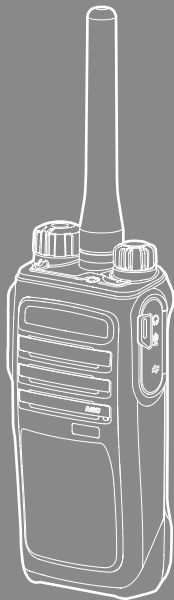

Instructional Icons



Indicates functions that are available on digital channel only.



Indicates functions that are available on analog channel only.

Functions marked with no function icons are available on both analog and digital channels.

Disclaimer

The Company endeavors to achieve the accuracy and completeness of this manual, but no warranty of accuracy or reliability is given. All the specifications and designs are subject to change without notice due to continuous technology development. No part of this manual may be copied, modified, translated, or distributed in any manner without the express written permission of us.

We do not guarantee, for any particular purpose, the accuracy, validity, timeliness, legitimacy or completeness of the Third Party products and contents involved in this manual.

If you have any suggestions or would like to learn more details, please visit our website at:<http://www.hytera.com>.

RF Radiation Information

This product must be restricted to operations in an Occupational/Controlled RF exposure Environments. Users must be fully aware of the hazards of the exposure and able to exercise control over their RF exposure to qualify for the higher exposure limits.

RF Radiation Profile

Radio Frequency (RF) is a frequency of electromagnetic radiation in the range at which radio signals are transmitted. RF technology is widely used in communication, medicine, food processing and other fields. It may generate radiation during use.

RF Radiation Safety

In order to ensure user health, experts from relevant industries including science, engineering, medicine and health work with international organizations to develop standards for safe exposure to RF radiation. These standards consist of:

- United States Federal Communications Commission, Code of Federal Regulations; 47CFR part 2 sub-part J;
- American National Standards Institute (ANSI)/Institute of Electrical and Electronic Engineers (IEEE) C95. 1-1992;
- Institute of Electrical and Electronic Engineers (IEEE) C95.1-1999;
- International Commission on Non-Ionizing Radiation Protection (ICNIRP) 1998.

FCC Regulations

Federal Communication Commission (FCC) requires that all radio communication products should meet the requirements set forth in the above standards before they can be marketed in the U.S, and the manufacturer shall post a RF label on the product to inform users of operational instructions, so as to enhance their occupational health against exposure to RF energy.

Operational Instructions and Training Guidelines

To ensure optimal performance and compliance with the occupational/controlled environment RF energy exposure limits in the above standards and guidelines, users should transmit not more than 50% of the time and always adhere to the following procedures:



- RF energy will be generated only when the radio is transmitting.
- The radio must be 2.5 centimeters away from human body when transmitting.

EU Regulatory Conformance

As certified by the qualified laboratory, the product is in compliance with the essential requirements and other relevant provisions of the Directive 1999/5/EC.

Please note that the above information is applicable to EU countries only.

Contents

1. Items in the Package	1
2. Product Overview	2
Product Controls	2
Programmable Keys	3
3. Before Use	3
Assembling the Radio	3
Charging the Battery	4
Checking the Battery Power	5
4. Status Indication	5
LED Indicator	5
5. Basic Operations	6
Powering On/Off	6
Adjusting the Volume	6
Selecting a Zone	6
Selecting a Channel	6
6. Call Services	7
Calling on Digital Channel 	7
Calling on Analog Channel (No Signaling) 	8
7. Feature Description	8
8. Troubleshooting	9
9. Care and Cleaning	10
10. Optional Accessories	11

Items in the Package

Please unpack carefully and check that all items listed below are received. If any item is missing or damaged, please contact your dealer.



Note

The frequency band is marked on the label of antenna; if not, please refer to the label on the radio for frequency band information.

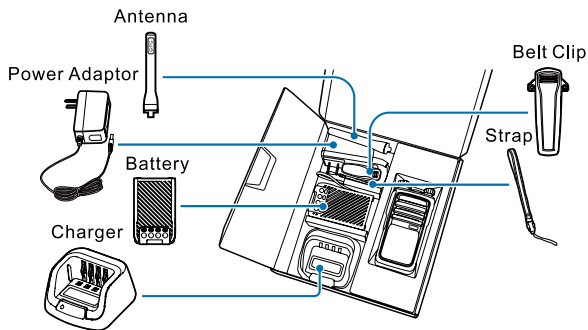
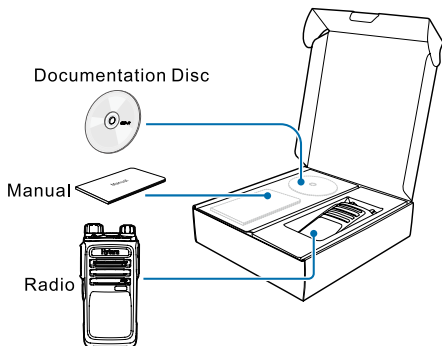

Note

All pictures in this manual are for reference only.

Product Controls

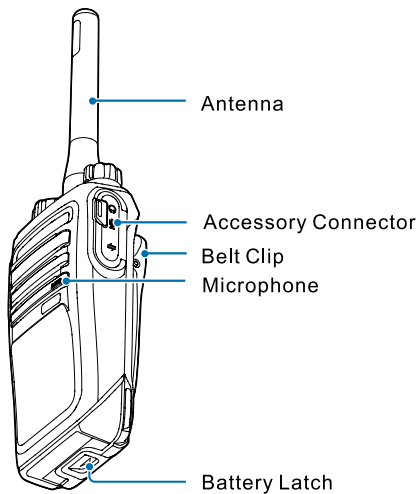
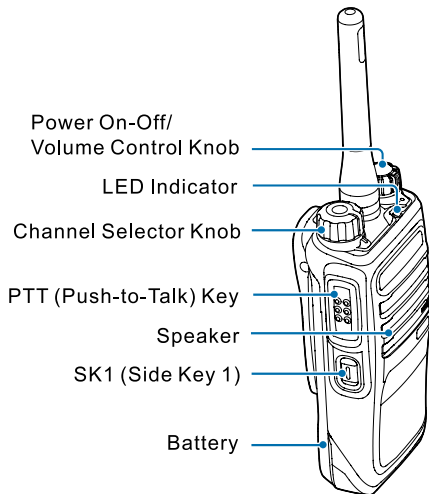

Programmable Keys

For enhanced convenience, you may request your dealer to program the **SK1** key as shortcut to certain feature. Please refer to the corresponding Feature Book for feature details.

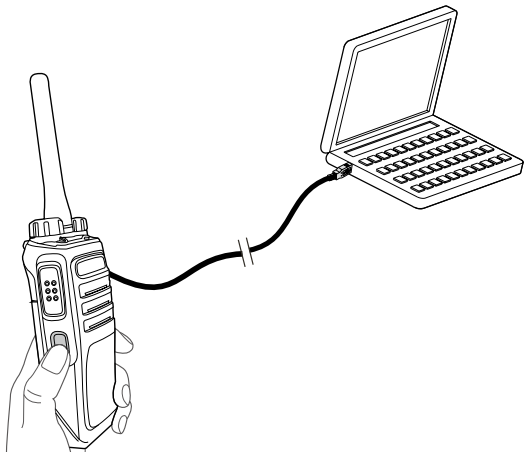

Assembling the Radio

1. Assembling the Battery

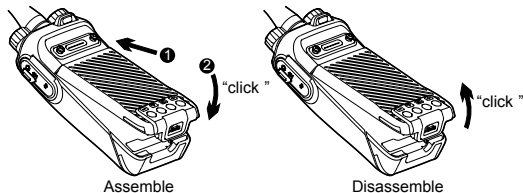

- To remove the battery, please turn off the radio first. Then slide the battery latch upwards to unlock the battery.
-  **Note**
- If not assembled with battery specified by Hytera, the radio will give an alarm tone to remind you when powering on. Afterwards, it will operate normally.

2. Assembling the Antenna





Do not swing the radio when holding it by the antenna, so as to avoid lowering the performance and shortening the life span of the antenna.

Caution

3. Assembling the Belt Clip

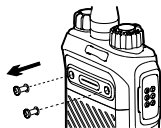

①

Remove the screws

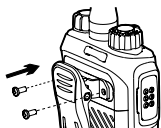

②

Assemble the Belt Clip

4. Assembling the Accessories

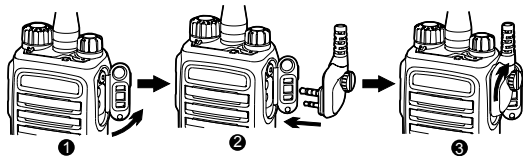

①

②

③

Charging the Battery

Please use the charger specified by the Company, and follows the charging steps as shown below.

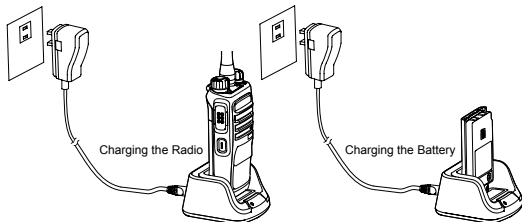

LED Indication	Current Status
The LED Indicator flashes red slowly	Standby (no load)
The LED Indicator glows red	Charging
The LED Indicator glows orange	90% charged
The LED Indicator flashes orange slowly	Low current charging
The LED Indicator glows green	Fully charged
The LED Indicator flashes red rapidly	Charging error

- Make sure the radio is powered off before charging. Read the Safety Information Booklet in advance to get necessary safety information.
- To achieve optimal battery performance, please charge the battery for at least 5 hours before initial use.



Caution

Checking the Battery Power

You may check the current battery power by holding the programmed **Battery Power Indicator** key preset by your dealer. Release the key to exit.



LED Indication	Battery Power
● The LED indicator glows green	■ High
● The LED indicator glows orange	■ Medium
● The LED indicator glows red	■ Low
● The LED indicator glows red and low battery alert sounds	■ Under the low battery threshold. Charge or replace the battery for proper radio operation

LED Indicator



LED Indication	Product Status
☀ The LED indicator flashes green	Powering on
● The LED indicator glows green	Receiving
● The LED indicator glows red	Transmitting
☀ The LED indicator flashes orange slowly	Scanning or roaming
☀ The LED indicator flashes orange rapidly	Emergency
● The LED indicator glows orange	The call is established successfully, and you can hold down the PTT key to talk

Powering On/Off

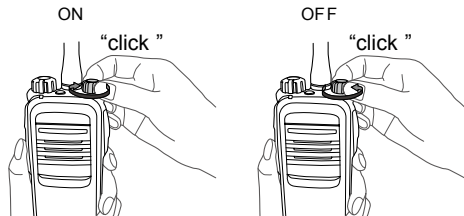

Adjusting the Volume

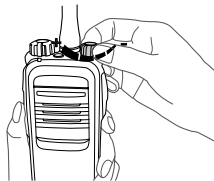

Selecting a Zone

You can include a group of channels with the same property in to a zone for convenient management. The radio supports three zones, each of which consists of up to 16 channels. You can switch to the appropriate zone by pressing the programmed **Zone Up** or **Zone Down** key preset by your dealer.



Selecting a Zone

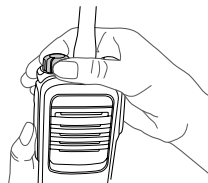

Selecting a Channel

Selecting a Channel

After the radio is powered on, you can rotate the **Channel Selector** knob to select an appropriate channel. You can also switch to the designated channel directly by pressing the programmed **Preset Channel** key preset by your dealer.

If the Channel Notify feature is enabled by your dealer, the radio will play the channel number upon channel switching.

After the radio is powered on, you can make different kinds of calls. To ensure optimal volume of the receiving radio, keep the microphone about 2.5 to 5 centimeters away from your mouth when transmitting.

The types of calls you may initiate are listed below:

- Private call: A call made to a private contact.
- Group call: A call made to the group contacts.
- All call: A call made to all the contacts on the current channel.



Calling on Digital Channel

You can initiate a private call, group call or all call (your radio must be programmed to allow you to use the all call service) through the same operations on digital channel. When calling back, the radio will make a call to the calling party in private call and all call (your radio must be

programmed to allow you to call back in an all call); but in group call, the radio will make a call to all parties involved when calling back.

Here we take the private call as example to illustrate the call process:

1. User A and B select the same digital channel.
2. User A holds down the **PTT** key to initiate a call.
You may preset a regular private call/group call/all call contact for each digital channel via your dealer.
3. By holding down the **PTT** key, user A can talk to the microphone when the LED indicator on the radio glows red.
4. User A releases the **PTT** key to finish talking.
User A can hold down the **PTT** key to talk when the LED indicator on the radio is glowing orange.
When receiving, the LED indicator on the radio glows green.
5. User B can receive the call without any operation. When receiving, the LED indicator glows green.
6. User B can hold down the **PTT** key to talk when the LED indicator on the radio is glowing orange.



Note

The duration of LED indicator glowing orange (Call Hold Time) is preset by your dealer. The call will end if neither one talks before this duration expires.

Calling on Analog Channel (No Signaling)

On the analog channel without signaling, the calling operations are the same as on the digital channel. The difference is that the called parties are all the users on the channel, rather than the preset contact for the channel.

Please refer to the corresponding Feature Book for calling operations on the analog channel with signaling.

Available features of this radio are listed below. Please refer to the corresponding Feature Book for details.

Feature Type	Detailed Feature
Radio Features	<ul style="list-style-type: none"> ● Radio setting: Power Level, Covert Mode ● Convenient functionality: Shortcuts, One Touch Call and VOX ● Rent ● Audio Optimization
Conventional Common Features	<ul style="list-style-type: none"> ● Scan ● Talk Around
Digital Features	<ul style="list-style-type: none"> ● Access management: Time-out-Timer (TOT), Transmission Management ● Basic voice services: Private Call, Group Call ● Auxiliary voice service: All Call ● Data service: Message ● Security: Encrypt ● Supplementary services ● Patented features: Pseudo Trunking, Priority Interrupt
Analog Feature	<ul style="list-style-type: none"> ● Mobility management: Roam ● Access management: Time-out-Timer (TOT), Transmission Management, Monitor, Squelch Off and Adjust Squelch Level ● Voice services ● Security: Scrambler ● Signaling: HDC1200, 5-Tone and 2-Tone

Troubleshooting

If the solutions below cannot fix the problems for you, or you may have some other queries, please contact us or your local dealer for more technical support.

Phenomena	Analysis	Solution
Power-on Failure.	The battery may be improperly installed.	Remove the battery and reassemble it.
	The battery power may be used up.	Recharge or replace the battery.
	The battery is poorly connected due to dirtied or damaged battery contacts.	Clean the battery contacts. If the problem cannot be solved, contact your dealer or authorized service center for inspection and repair.
During receiving, the voice is weak, discontinuous or totally inactive.	Low battery voltage.	Recharge or replace the battery
	Low volume level.	Increase the volume by rotating the Volume Control knob.
	The antenna may be loosened or improperly installed.	Reassemble the antenna after turning off the radio.
Unable to communicate with other members.	The speaker may be blocked or damaged.	Clean the surface of the speaker. If the problem cannot be solved, contact your dealer or authorized service center for inspection and repair
	The frequency or signaling may be inconsistent with that of other members.	Set your TX/RX frequency and signaling to the same as that of other members.
	The channel type (digital/analog) may be set inconsistently.	Make sure all members are on the same digital/analog channel.
Irrelevant communication or noise is heard on the channel.	You may be too far away from the group members.	Move towards other members.
	You may be interrupted by radios using the same frequency.	Change the frequency, or adjust the squelch level.
	The radio may be set with no signaling.	Set signaling for all member radios to avoid interference at the same frequency. And change the signaling settings for all portable radios at the same time.
The noise is too loud.	You may be too far away from other members.	Move towards other members.
	You may locate in an unfavorable position. For example, your communication may be blocked by high buildings or frustrated in the underground areas.	Move to an open and flat area, and restart the radio to try again.
	You may suffer from external disturbance (such as electromagnetic interference).	Stay away from equipment that may cause interference.

To guarantee optimal performance as well as a long service life of the product, please follow the tips below.

Product Care



Do not pierce or scrape the product.



Keep the product far away from substances that can corrode the circuit.



Do not hold the product by its antenna directly.



Do not hold the product by its earpiece cable directly.



Attach the accessory connector cover when the accessory is not in use.

Product Cleaning





Caution Turn off the product and remove the battery before cleaning.

- Clean up the dust and fine particles on the product surface and charging piece with a clean and dry lint-free cloth or a brush regularly.
- Use neutral cleanser and a non-woven fabric to clean the keys, control knobs and front case after long-time use. Do not use chemical preparations such as stain removers, alcohol, sprays or oil preparations, so as to avoid surface case damage.
- Make sure the product is completely dry before use.

Optional Accessories

The following items are the main optional accessories for the radio. For more information of other accessories, please consult your local dealer.

 **Caution** Use the accessories specified by Hytera only. If not, the Company shall not be liable for any losses or damages arising out of use of unauthorized accessories.

 Power Supply: Li-Ion/Ni-MH battery, including Dual-Pocket Charger and Switching Power),
MCA08 MCU Multi-unit Rapid-rate Charger (for Li-Ion/Ni-MH batteries),
CH10A06 Dual-Pocket MCU Charger Kit(for
PS7501 AC/DC Adaptor,
MCA05 Battery Optimizing System

 Audio: EAM15 3-Wire Earpiece with Transparent Acoustic Tube (Beige),
ESM14 Remote Earbud,
EAM17 Remote Earpiece with Transparent Acoustic Tube,
EHM20 Remote Swivel Earset,
EHM19 Remote C-Earset,
SM08M3 Remote Speaker Microphone,
SM13M1 Remote Speaker Microphone (IP55)



Cable: PD50X Programming & Downloading Functional Cable



Carry Accessories: NCN011 Nylon Carrying Case

致用户

非常感谢您对我们产品的青睐！本手册旨在让您快速掌握本产品的使用，如需了解产品详细功能和操作，请参考《功能手册》。

本手册适用于以下机型：

PD502i 数字手持终端

数字手持终端

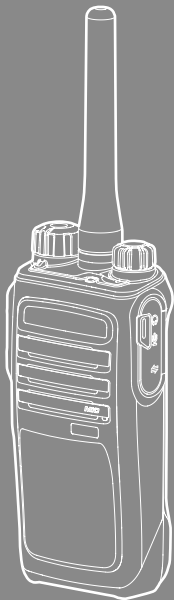

图标说明



：表示数字信道独有的功能，只能在数字信道上使用。



：表示模拟信道独有的功能，只能在模拟信道上使用。

未用图标区分的功能在数字信道和模拟信道上都可使用。

免责声明

本手册在编制过程中力求内容的准确性与完整性，但对于可能出现的错误或疏漏，我司不承担任何责任。由于技术的不断发展，我司保留不予通知而更改产品设计规格的权利。未经我司事先书面授权，不得以任何形式对本手册进行复制、修改、翻译和散发。

本手册中涉及的第三方产品和内容归第三方所有，我司对其准确性、有效性、及时性、合法性或完整性均不提供保证。

如需更多信息或对本手册有任何建议，欢迎访问我们的网站：<http://www.hytera.com>，或拨打我司服务热线：400-830-7020。

射频辐射信息

本产品仅限于能够满足射频能量辐射要求的职业应用。使用者必须清楚了解射频辐射危害并可采取相应措施，满足射频辐射限定要求。

射频辐射常识

射频指可以辐射到空间的电磁频率，是通讯、医疗、食品加工等领域广泛使用的一种技术，在使用过程中会产生一定的射频辐射。

射频辐射安全

为了确保用户的身心健康，来自科学、工程、医药、健康和工业的专家们与相关组织共同研究制定了射频辐射标准和准则，如下所示：

- 美国联邦通信委员会联邦政府法规汇编第 47 卷第 2 部分 J 子部分。
- 美国国家标准协会 (ANSI)/ 电气和电子工程师协会 (IEEE) 标准 C95.1-1992 版。
- 电气和电子工程师协会标准 C95.1-1999 版。
- 国际非电离辐射防护委员会 (ICNIRP) 于 1998 年颁布的标准。

美国联邦通信委员会监管要求

按照美国联邦通信委员会的监管要求，本产品必须符合美国联邦通信委员会射频辐射限制规定，否则不能在美国市场上销售。并要求制造商可通过在产品上张贴标签的方式，告知用户应注意的事项，提高用户的防辐射意识。

射频辐射控制及操作说明

为了使产品发挥最佳性能及确保符合上述标准中有关职业或受控环境中的辐射限制要求，发送时间不得超过额定因数的50%（最高50%的时间发射），且需遵照下列说明：

- 仅在发射（讲话）时产生射频能量辐射，接收（收听）和待机时均不会产生。
- 发射时终端与身体的距离至少保持在 2.5 厘米以上。

欧盟指令符合性声明

本产品经独立第三方机构认证，符合欧盟指令“1999/5/EC”中的相关要求。

请注意，本声明仅适合欧盟国家。

目 录

1. 包装清单	1	6. 呼叫	7
2. 熟悉本产品	2	数字信道呼叫 	7
部件介绍	2	模拟信道呼叫（无信令） 	7
可编程键	3	7. 功能说明	8
3. 用前准备	3	8. 故障处理	9
安装本机	3	9. 保养与清洁	10
充电说明	4	10. 选购配件	11
查看电量	5	11. 保修范围与期限	11
4. 状态指示	5		
LED指示灯	5		
5. 基本操作	6		
开机与关机	6		
调节音量	6		
选择区域	6		
选择信道	6		

包装清单

包装盒内含有以下物品。如有任何物品丢失或损坏，请与您所购产品的经销商联系。



备注

天线频段请参考天线底部色环标签内容。若标签未注明频段，则参考主机标签上的具体频段。

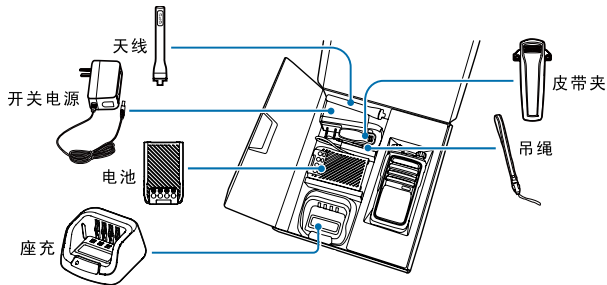
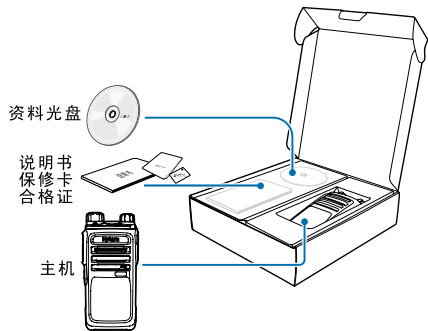

备注

本手册的所有图片仅为示例，请以实物为准。

部件介绍

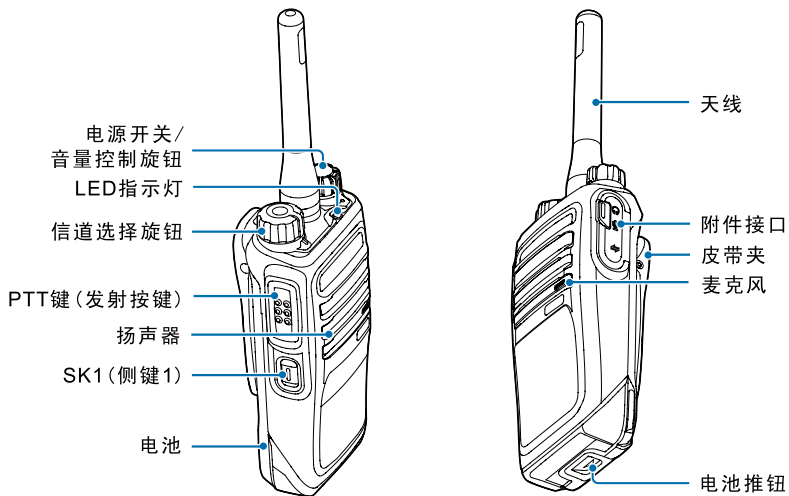

可编程键

为了提升操作便利性，本产品提供1个可编程键：SK1。可由您的经销商编程为功能快捷键，详情请咨询您的经销商。各功能的详细介绍您可以参考对应的《功能手册》。

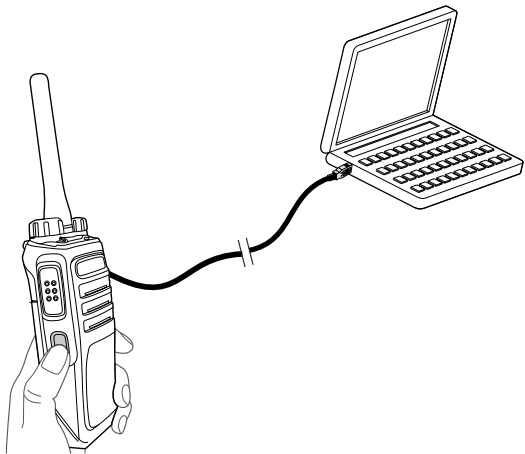

安装本机

1. 安装电池

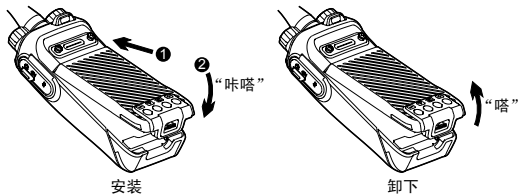

- 如需卸下电池，请先关闭本产品，然后将底部电池推钮往上提起，并取出电池。
- 如安装非 Hytera 电池，开机上电提示告警音，开机后正常使用。

2. 安装天线



- 请勿手持天线顶端甩动本产品，否则会降低本产品天线的工作性能和使用寿命。

3. 安装皮带夹

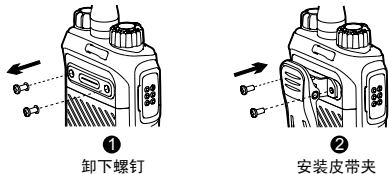

4. 安装附件

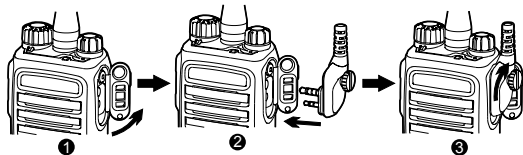

充电说明

请使用我司指定的充电座对电池进行充电，充电示意图如下图所示。

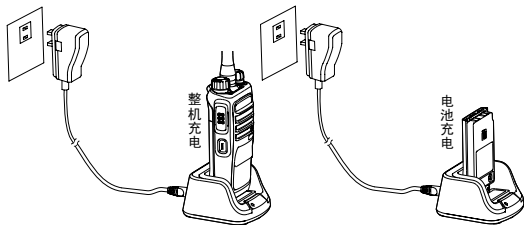

指示灯显示	当前充电状态
红色LED慢闪	待机（空载）
红色LED长亮	正在充电
橙色LED长亮	电池已充满90%的电量
橙色LED慢闪	正在激活
绿色LED长亮	电池已经充满
红色LED快闪	充电过程中出现故障



- 注意**
- 为整机充电时，建议关闭本产品，并提前参阅《安全信息手册》，以获取必要的电池安全信息。
 - 为获得最佳电池性能，首次充电时，请至少充电 5 小时。

查看电量

如果经销商为本产品设置了【电池电量提示】快捷键，您可以通过按住该快捷键查看电池的当前剩余电量。松开该按键即可退出。

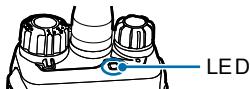

LED提示	电池电量
● 绿灯亮	电量高
● 橙灯亮	电量中
● 红灯亮	电量低
● 红灯亮+低电提示音	电量不足，达到低电阈值，请尽快充电或者更换电池，以确保本产品保持正常工作。

LED指示灯

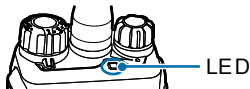

指示灯状态	产品状态
绿灯闪烁	正在开机
绿灯长亮	正在接收
红灯长亮	正在发送
橙灯慢闪	正在扫描或者漫游
橙灯快闪	紧急状态
橙灯长亮	呼叫建立成功，在橙灯长亮期间您可以按住【PTT】键进行回呼

开机与关机



调节音量

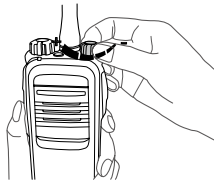

选择区域

区域是一个信道组，您可以将具有相同属性的信道列入一个区域中，这样便于您对现有信道进行有效管理。本产品支持3个区域，每个区域最多包含16个信道。若经销商为您设置了【区域上调】/【区域下调】快捷键，您可通过按此快捷键可切换至所需区域。



选择区域

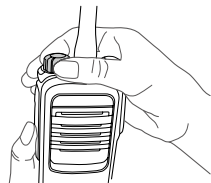

选择信道

选择信道

开机后，旋转【信道选择】旋钮即可选择所需信道。你也可以通过按【预设信道】快捷键（由经销商设置），切换到指定信道。

如果经销商为本产品开启了信道播报功能，此处切换信道时本产品将播报信道号。

开机成功后，您可以进行各种呼叫操作。为了保证接收方最佳接收音量，发射时请保持麦克风距离嘴大约2.5~5厘米。

- 个呼：对单个用户发起呼叫。
- 组呼：对组内的所有用户发起呼叫。
- 全呼：对当前信道上所有用户发起呼叫。

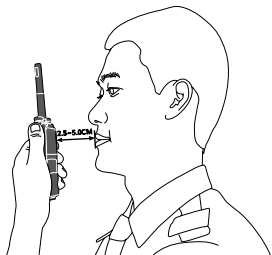

数字信道呼叫

您可在数字信道上进行个呼、组呼和全呼（全呼权限需要由经销商开启）。各呼叫的操作方法相同，区别在于：组呼过程中，回呼的对象是所有参与呼叫的人；个呼和全呼过程中，回呼的对象是主叫，全呼具有回呼权限需要由经销商开启。

以个呼操作为例介绍操作过程，用户A呼叫用户B的过程如下。

1. A和B选择相同的数字信道。
2. A按住【PTT】键发起呼叫。
您可通过经销商为每个数字信道预设一个“发射联系人”，该联系人可以是组呼/全呼联系人。
3. LED红灯常亮期间，A对着麦克风讲话。
4. A讲话结束后松开【PTT】键接听。
LED橙灯常亮期间，A可按住【PTT】键讲话。
接收语音期间，LED绿灯常亮。
5. B无须任何操作即可接听呼叫，接收语音期间LED绿灯常亮。
6. LED橙灯常亮期间，B可按住【PTT】键讲话。



LED 橙灯常亮时间（即呼叫保持时间）由经销商设置，如果期间无人讲话，则呼叫结束。

模拟信道呼叫（无信令）

在不带信令的模拟信道上，呼叫的操作方法同数字信道，区别在于，呼叫对象是选择该信道的所有用户，而不是信道关联的“发射联系人”。

使用信令发起呼叫的操作方法请参见本产品配套的《功能手册》。

本机型所支持的功能如下表所示，相关功能详细描述请参考《功能手册》。

功能分类	具体功能
整机功能	<ul style="list-style-type: none">● 设置对讲机：功率级别，隐蔽模式。● 操作便利性：功能快捷键，一键呼叫，声控。● 租赁。● 声音优化。
常规公用功能	<ul style="list-style-type: none">● 扫描。● 脱网。
数字功能	<ul style="list-style-type: none">● 接入管理：超时禁发，发射管理。● 基本语音业务：个呼，组呼。● 辅助语音业务：全呼。● 数据业务：短消息。● 安全：加密。● 补充业务。● 专利功能：虚拟集群，优先打断。● 移动管理：漫游。
模拟功能	<ul style="list-style-type: none">● 接入管理：超时禁发，发射管理，监听，静噪打开，静噪级别调整。● 语音业务。● 安全：扰频。● 信令：HDC1200，五音，两音。

故障处理

如下述方法仍未解决您的问题，或您遇到一些其他的故障，请联系当地经销商或我司以获取更多的技术支持。

故障描述	原因分析	解决方法
无法开机	电池可能未正确安装	取出电池并重新装入。
	电池电量可能已经耗尽	充电或更换电池。
	电池触点污浊或受损而导致接触不良	清洁电池触点。如仍不能解决问题，请联系经销商或我司指定维修点进行检修。
接收信号时声音小、断续或无声	电池电压过低	充电或更换电池。
	音量较小	通过【音量控制】旋钮调大音量。
	天线松动或安装不到位	关机后重新安装天线。
无法与组内其他成员通话	扬声器堵塞或受损	进行简单的外部清洁。如仍不能解决问题，请联系经销商或我司指定维修点进行检修。
	所用频率或信令设置与组内其他成员不同	设置与组内其他成员相同的频率和信令。
	数字、模拟信道设置不当	设置相同的数字信道或模拟信道。
信道中出现其他通话声或杂音	距离组内其他成员太远	尽量靠近其他成员，确认位于其有效通讯范围之内。
	受到同频用户的干扰	更改为新的频点，或调整静噪级别。
	未设置信令	对组内所有对讲机进行信令设置，以防止同频干扰。但必须同时更改组内所有手持终端的信令设置。
噪声较大	与其他成员之间的通讯距离过远	靠近其他成员。
	所处位置不佳，如受高大建筑物阻挡，或位于地下室等	移至开阔平坦地后，开机重试。
	受外界环境或电磁干扰	避开可能引起干扰的设备。

为了保证本产品发挥其良好性能，以及延长其使用寿命，请熟悉以下内容，以便更好地对本产品进行日常保养与清洁。

保养



请勿用硬物穿刺或刮花本产品。



请勿将本产品存放于含有腐蚀电子电路物质的环境。



携带或使用本产品过程中，请勿用手提天线。



携带或使用本产品过程中，请勿用手提耳机线。



当不使用附件时，请盖好附件接口盖。

清洁



清洁之前，请关机并取出电池。

- 请定期使用洁净干燥的无绒布或毛刷拭去本产品表面及充电极片附着的粉尘。
- 本产品的按键、控制旋钮和机壳极易变脏。可用中性洗涤剂和无纺布对其进行清洁，请勿用去污剂、酒精、喷雾剂或石油制剂等化学药剂进行清洁，以避免产品表面和外壳受损。
- 清洁之后，务必保证本产品彻底干燥，否则请勿使用。

选购配件

本产品主要的选购附件已包含在如下列表中，如需更多附件信息，请咨询您当地的经销商或拨打我司服务热线400-830-7020。



请使用我司指定的配件。若擅自使用未经许可的配件，则由此所导致的一切后果，由用户自行负责。



电源类：

MCA08锂电/镍电MCU快速排充
CH10A06锂电/镍氢电MCU双插槽充电座套件
(包括双兜座充和开关电源)
PS7501 AC/DC适配器
MCA05电池分析仪



音频类：

EAM15三线透明管耳机（米色）
ESM14分体耳塞式耳机
EAM17分体透明管式耳机
EHM20分体可调节耳挂式耳机
EHM19分体C型耳挂式耳机
SM08M3扬声器话筒
SM13M1扬声器话筒（IP55）



线材类：

PD500写频&下载双功线材



携带类：

NCN011尼龙携带外套

保修范围与期限

我司承诺，凡我司生产的产品，自购买之日起，在正常使用、操作与维护条件下，出现材料或制造工艺方面的缺陷，可享受以下规定的保修服务。

主机

24个月

标配附件（包括电池、充电座）

12个月

Hytera

is the trademark or registered trademark of Hytera Communications Corp., Ltd.

© 2018 Hytera Corp., Ltd. All Rights Reserved.

Address: HYT Tower, Hi-Tech Industrial Park North, Beihuan
RD., Nanshan District, Shenzhen, China

Postcode: 518057

<http://www.hytera.com>

Hytera

是海能达通信股份有限公司的商标或注册商标

©2018 Hytera Corp., Ltd. 版权所有

地址: 深圳市南山区北环大道9108号

邮编: 518057

服务热线: 400-830-7020

<http://www.hytera.com>

L06774 O10745



811PD5000000